

DREAMWORKS
SHREK

SUPER SLAM



EVERYONE 10+
E
10+
CONTENT RATED BY
ESRB

ACTIVISION

WARNING: READ BEFORE USING YOUR PLAYSTATION®2 COMPUTER ENTERTAINMENT SYSTEM.

A very small percentage of individuals may experience epileptic seizures when exposed to certain light patterns or flashing lights. Exposure to certain patterns or backgrounds on a television screen or while playing video games, including games played on the PlayStation 2 console, may induce an epileptic seizure in these individuals. Certain conditions may induce previously undetected epileptic symptoms even in persons who have no history of prior seizures or epilepsy. If you, or anyone in your family, has an epileptic condition, consult your physician prior to playing. If you experience any of the following symptoms while playing a video game — dizziness, altered vision, eye or muscle twitches, loss of awareness, disorientation, any involuntary movement, or convulsions — **IMMEDIATELY** discontinue use and consult your physician before resuming play.

WARNING TO OWNERS OF PROJECTION TELEVISIONS:

Do not connect your PlayStation 2 console to a projection TV without first consulting the user manual for your projection TV, unless it is of the LCD type. Otherwise, it may permanently damage your TV screen.

USE OF UNAUTHORIZED PRODUCT:

The use of software or peripherals not authorized by Sony Computer Entertainment America may damage your console and/or invalidate your warranty. Only official or licensed peripherals should be used in the controller ports or memory card slots.

HANDLING YOUR PLAYSTATION 2 FORMAT DISC:

- This disc is intended for use only with PlayStation 2 consoles with the NTSC U/C designation.
- Do not bend it, crush it or submerge it in liquids.
- Do not leave it in direct sunlight or near a radiator or other source of heat.
- Be sure to take an occasional rest break during extended play.
- Keep this compact disc clean. Always hold the disc by the edges and keep it in its protective case when not in use. Clean the disc with a lint-free, soft, dry cloth, wiping in straight lines from center to outer edge. Never use solvents or abrasive cleaners.

TABLE OF CONTENTS

Getting Started	2
Starting Up	3
Game Controls	4
In-Game Menu	6
Main Menu	9
Single Player	9
Multiplayer	11
Playing the Game	12
Power-Ups: Weapons, Potions & Magical Items	12
Characters	15
In-Game Pause Menu	16
Saving & Loading	17
Credits	17
Customer Support	19
Software License Agreement	20



GETTING STARTED

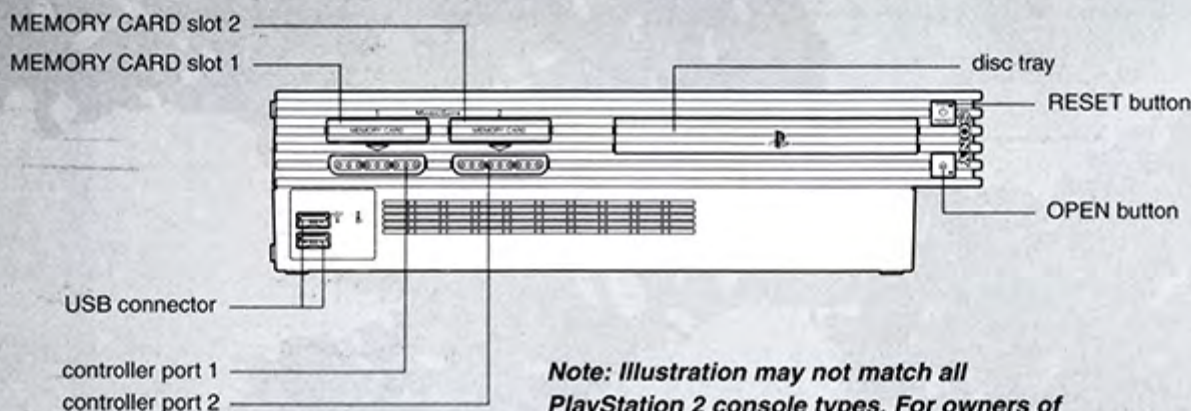

Note: Illustration may not match all PlayStation 2 console types. For owners of SCPH-70000 series PlayStation 2 systems, refer to the setup instructions supplied with your system.

Set up your PlayStation®2 computer entertainment system according to the instructions in its Instruction Manual. Make sure the MAIN POWER switch (located on the back of the console) is turned on. Press the **RESET** button. When the power indicator lights up, press the **OPEN** button and the disc tray will open. Place the *Shrek® SuperSlam* disc on the disc tray with the label pointing up. Press the **Open** button again and the disc tray will close. Attach game controllers and other peripherals, as appropriate. Follow on-screen instructions and refer to this manual for information on using the software.

Memory Card

Shrek® SuperSlam requires a memory card (8MB)(for PlayStation®2) to save your games. A saved game's data takes up 64Kb. You can obtain a memory card through the retailer where you purchased your PlayStation®2 game console or this game. To access your memory card (8MB)(for PlayStation®2), insert it into MEMORY CARD slot 1.



STARTING UP

DUALSHOCK[®]2 Analog Controller

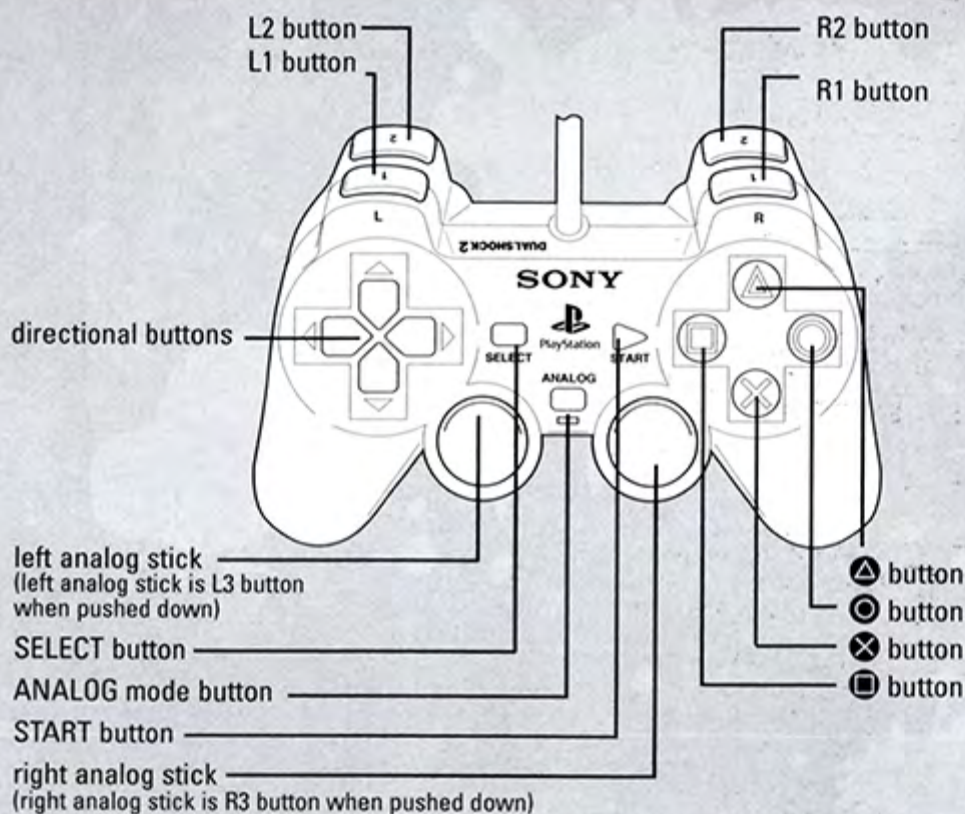

To select menu options, use the directional buttons to navigate the menu options. Highlight the desired option and press the **×** button to accept. To select a menu option, follow the on-screen button prompts and press the **×** button to accept and the **△** button to go back to navigate through the menu options. *Shrek[®] SuperSlam* supports the **DUALSHOCK[®]2** analog controller. When the mode indicator is on, the left analog stick works the same as the directional buttons.

Menu Controls

Directional buttons	Navigate Menu
× button	Tap Button to Accept
△ button	Tap Button to Go Back to Previous Screen
START	Access Pause Menu (in game)
SELECT	Not Used



GAME CONTROLS

DUALSHOCK® 2 Analog Controller

R1 button – **Block/Deflect**

R1 button + Left Analog Stick – **Evade Dash**

R1 button – **Block/Cancel**
(Cancel charge attack when pressed during charge.)

L1 button – **Equip/Un-equip Weapon**

START button –
Pause Game Menu

SELECT button

ANALOG mode button

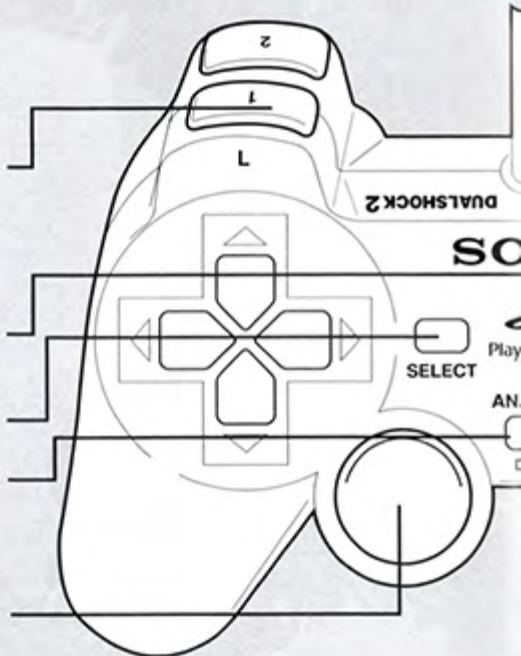

Left Analog Stick – **Move**

Right Analog Stick – **Evade Dash**



Dash Attacks – Tap the left analog stick in the direction you want to go and press the  button to perform a dash attack.

Note: Not all characters have a dash attack.

Up Attack – Press the  and  buttons at the same time.

Wall Attacks – Stand next to a wall and press the  button while holding the left analog stick in the direction of the wall to do a wall attack.



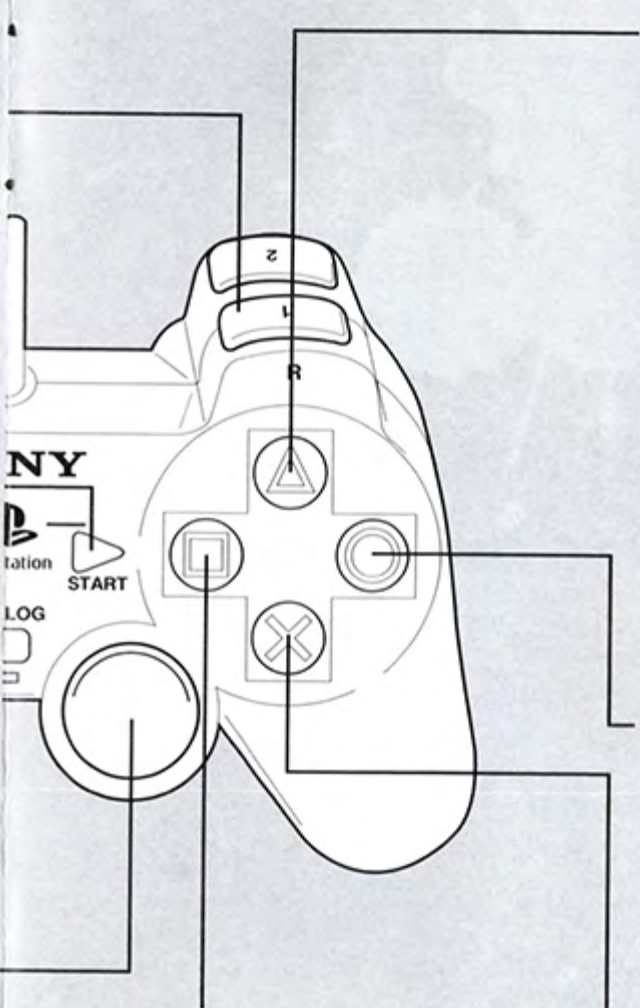

- △ button – **Strong Attack**
- △ button (press when meter is full) – **Slam Attack**
- △ button – (press and hold) **Charged Attack**
- △ button – **(with object) Throw Object**
- △ button – **Use Weapon**



- button – **Grab/Throw**



- button – **Fast Attack**
- button – **(with object) Throw**
- button – **Use Weapon**

- ⊗ button – (twice to double jump) **Jump/Double Jump**



IN-GAME MENU

Character Icons—Character portraits are at the bottom of the screen. Below the portraits is the Slam Meter, which measures how much Slamergy you've collected during a round.

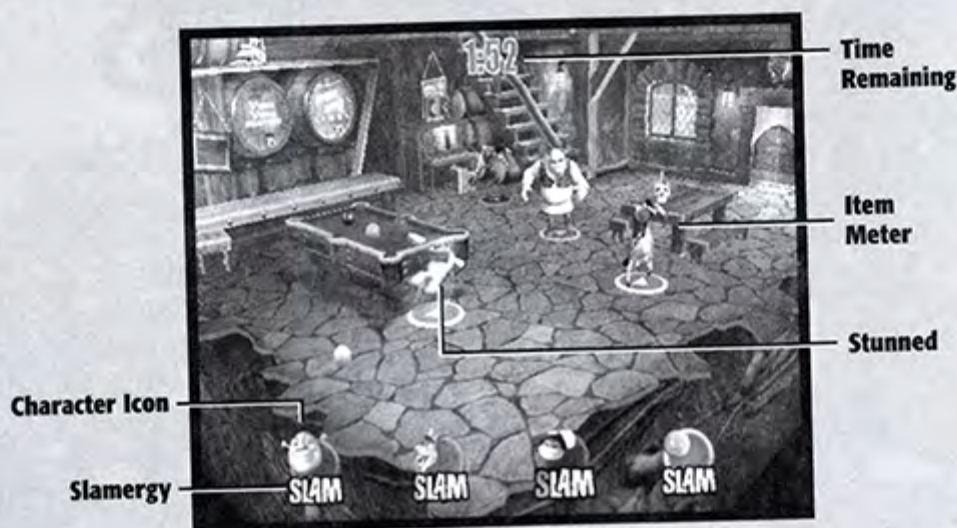

Leader Icon – Indicates the slam leader's position.



Slam Prompt – This appears above your head when your Slam Meter is full. Use this button to execute your Slam Attack.

Wiggle Icon – Whenever you've been knocked down or grabbed, this icon appears above your character. Wiggle the left analog stick rapidly to speed up your recovery.



Time Remaining – The timer indicates how much time is left in a round and defaults to two minutes.



The Slam Meter

At the heart of *Shrek® SuperSlam* is...you guessed it, the Slam! The Slam Meter is under the character portraits. Fill up the meter with Slamergy, then Slam your opponents. Your characters will have a glowing aura around them when they're Slam-ready. You get multiple attempts to Slam someone, so be careful! Once you use up the Slam, you have to collect more Slamergy to fill up your meter again. How do you get Slamergy? Battle with your friends! The more advanced combos you make, the faster you fill the Slam Meter.

Beat your opponents by getting the most Slams in the round. Try to Slam as many of your opponents at one time as you can to maximize your score.

Remember to watch out for your opponents! When you are hit by one of their Slams, you'll lose a Slam point. But this can work in your favor, because each time you Slam your opponent, not only will you get a Slam, but they lose one as well. This is important to remember when you're losing.



TABLE OF CONTENTS-1 • GETTING STARTED-2 • GAME CONTROLS-4 • **IN-GAME MENU-6** • MAIN MENU-9
SINGLE PLAYER-9 • MULTIPLAYER-11 • PLAYING THE GAME-12 • POWER-UPS-12 • CHARACTERS-15
IN-GAME PAUSE MENU-16 • SAVING & LOADING-17 • CREDITS-17 • CUSTOMER SUPPORT-19

Advanced Moves – All Characters

Evade Dash – Right analog stick or move while blocking (left analog stick + the **R1** button).

- Your **evade dash** can both get you out of trouble and sneak you into the middle of it. Tap your right analog stick in the direction you want to go.

*Hint: Try using a fast attack (the **□** button) or a strong attack (the **△** button) while performing an **evade dash**. You'll end your **evade dash** with a surprise attack.*

Air Attack – Fast or strong attack while in mid-air (the **□** or **△** button in air).

Up Attack – Simultaneously press jump and fast attack (the **□** + **×** buttons).

- It's raining cats and ogres! Press jump and fast attack together to counterattack your opponent's air attacks with an **up attack** (the **□** + **×** buttons).

Charge Attack – Hold your **strong attack** (hold the **△** button).

- Try using your **charge attack** just as your opponent is recovering from a missed attack.

Deflect – If you time your **block** to the very last moment, you can deflect thrown objects back at the thrower! Just be careful they don't do the same right back at you.

Block Cancel – Use your block to cancel your charge attack (the **R1** button).

- Fake-out your opponents. Cancel your **charge attack** by pressing the **block** button before your **charge attack** is unleashed.

Fast Drop – Use your **block** in mid-air to drop faster.

*Hint: Each character has a **block breaker**. Find and use them to take down those block-happy opponents.*



Advanced Moves – Character Specific

Don't be a one-trick Donkey! Different combos have different effects. Explore your **combo tree** to discover all your moves. The more **combos** you learn, the more tactics you'll have to use against your opponent. Find all your favorite character's **strengths** and **weaknesses**.

Dash Attack – Tap a direction with **fast attack** (tap left analog stick + the  button).

Air Dash – Some characters can do a dash attack while you're in mid-air.

- Time your **air dash** correctly and you can strike opponents who are on the ground.
- Whether you're chasing down your opponents or running away, try to combo an **air dash** into an **evade dash** to cover more ground.

Wall Attack – **Fast attack** while pressing up against walls (left analog stick + the  button).

- Surprise your opponents with a sudden change in direction. When you're chased into a wall, use a **wall attack**.

Air Wall Attack – Do a wall attack while you're in mid-air.

- Try using an **air dash** to **wall air attack** combo.

Note: Not all characters have an air dash.

Charge Throw – Hold your throw to increase your throw distance (hold the  button).

- Some characters have a **charge throw** attack. Use it to get more Slamergy.

Hint: When exploring your combo tree, remember which attacks knock down your opponents so you can use knockdown attacks to set up air attacks and slams.

*Hint: Know thy opponent. If you're taking damage from an **enemy combo**, right before the end of your enemy's combo, there is a **block window** of opportunity. Time your **block** right and you'll interrupt an enemy's attack before it's finished, leaving them vulnerable.*

*Hint: Fiona and Prince Charming can do an **air evade**. While in the air, press in the direction you want to evade and **block** at the same time.*



MAIN MENU

Start Game

When you first start up *Shrek® SuperSlam*, you'll have three choices on the Main Menu:

- **Single Player:** View the choices of available single-player games.
- **Multiplayer:** Play Melee mode with up to four players.
- **Options:** Modify some game characteristics.



Options

Select Options from the Main Menu to modify the following settings:

- **Music Volume:** Adjust music volume.
- **SFX Volume:** Adjust sound effects volume.
- **Voice Volume:** Adjust voiceover volume.
- **Vibration:** Turn vibration on/off.
- **Subtitles:** Turn subtitles on/off.
- **Over the Hedge Trailer:** View the game trailer from the upcoming DreamWorks movie.
- **Credits:** View the game credits.

Hint: Block, block, block! If your opponent can't get any Slamergy, then he or she can't Slam!

Bonus Hint: Remember, you can attack while holding down your **block** button, which allows you to counterattack much easier.

SINGLE PLAYER

Story

Donkey has invited his friends over to watch some TV. Unfortunately, Donkey and Dragon's little Dronkeys are running amok, as children tend to do, and won't settle down for their bedtime. Shrek suggests reading a bedtime story to the kids, but just as Donkey gets started, one of the Dronkeys lets out an excited belch of fire and



sets the storybook ablaze. With no other way to get the Dronkeys to sleep, Shrek and his friends start to make up their own magical stories. Starting at Chapter 1, play through each increasingly fantastical tale as one of the classic or brand new characters in the land of Far Far Away. Let's hope tales of valor, lost-honor and late-night drive-thru windows will be enough to lull the little Dronkeys to sleep.



Mega Challenges

Mega Challenges are single-player mini-games. Not for the weak of heart or spirit, there are 45 Mega Challenges and seven bonus challenges in all, which will unlock untold rewards along the way. **Play this mode to unlock additional characters and arenas.**

Melee

Face off against one, two or three computer opponents in a two-minute timed battle. Whoever has the most Slams at the end of the round wins. You'll have access to any character or arena you've already unlocked and saved to your memory card (8MB)(for PlayStation®2).

Melee Options

Enter the Melee Options by pressing the  button on the Level Select screen.

You can adjust the settings for Slam Limits, game speed and more before you go into battle.

Options consist of:

Mode – Normal, Last Player Standing and First to Slam.

Game Speed – Move character faster.

Time Limit – 30 second intervals all the way up to 10 minutes (No Slam Limit in Place).

Slam Meter – Slow Gain, Medium Gain, Fast Gain (how fast the meter increases); Slow Drain, Medium Drain, Fast Drain (how fast the meter is depleted), OFF.



Sudden Death Slam Meter – Slow Gain, Medium Gain, Fast Gain (how fast the meter increases); Slow Drain, Medium Drain, Fast Drain (how fast the meter is depleted); OFF.

Full Slam Meter – Use Slam Attack, any hit Slams.

Slammed Penalty – Does not give negative Slam points for being slammed.

Skill Level

You can change all characters' difficulty settings, which range from 1 (Idle) to 10 (Rage of Ogres). These affect how smart the computer-controlled characters are.

Training

Learn the basic moves for your characters. Attacks, combos and the like are all covered here. Some of the more advanced techniques are also covered in Mega Challenges mode, so make sure to check there as well.



Trophy Room

Check out all the trophies you've collected.

MULTIPLAYER

Melee – Melee lets you play with up to three friends (with the use of a Multi-Tap).

King of the Hill – In this mode, you gain points by being on top of the hill and defending it from all comers. Whoever has amassed the most points at the end of the round wins.

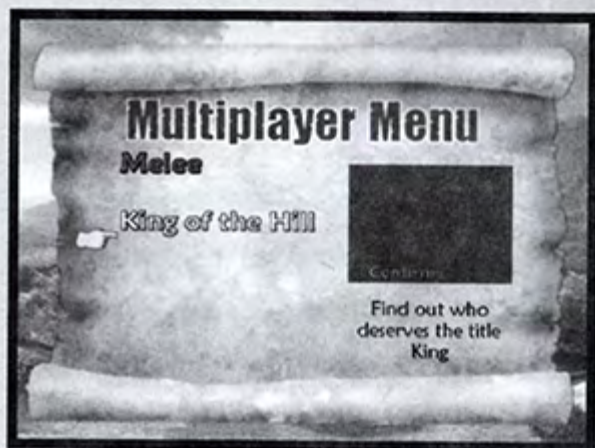

PLAYING THE GAME

Character Selection Screen – This is where you can choose any of the ten default *Shrek*[®] characters, or any of the ten additional characters you have unlocked during the course of gameplay. To select a character, move the Character Select indicator over the portrait of your chosen character using either the directional pad or the left analog stick. Confirm your selection by pressing the **X** button. Can't decide which character you want to play or just want to be surprised? Select **?** and you will be assigned a character at random. You can change costumes by selecting a character and pressing the **X** button.

Choosing a Team: Assigning teams allows you and your partner(s) to pool your Slam points. The team with the highest Slam point total wins. Choose teams using the directional pad. Confirm by pressing the **X** button.

Now that you've set up your character, it's time to pick out which level you want to battle in. Press the **START** button to proceed to the Level Select screen.

Level Select Screen – Choose which level or location in the *Shrek*[®] universe you intend to pound your opponent(s) silly in. Use the directional pad or left analog stick to move around the map of Far Far Away. Select a location by pressing the **X** button. Enter the melee option from the Level Select Screen by pressing the **□** button.

POWER-UPS: WEAPONS, POTIONS & MAGICAL ITEMS

You'll find these sweet babies scattered around every level of *Shrek*[®] *SuperSlam*. Each power-up has a different effect, either on you or your opponents. Use them wisely and often, because they can often be the deciding factor in a close battle.

Weapons

These power-ups have the unique ability to be holstered, or stored for later use, once you've collected them. The catch is that you can only store one weapon at a time. Press the **L1** button to holster/draw your weapon, and the **□** or **△** button to use it. A meter over your character's head indicates how many more uses you have for the weapon. Once the meter is empty, your character will automatically throw the weapon. Pick up something you don't want? Draw it and press the **○** button to drop it.





Giant Ham – Why? Because they're funny.

Fart Wand – Harness the power of Shrek! The Fart Wand grants whoever wields it three of Shrek's Green Storm attacks.



Floating Air Mines – A quiver-shaped backpack full of oversized, medieval rockets makes for a great anti-air attack weapon.

Hammer of Smiting – A giant silver hammer made for smiting your opponents!



Pot O' Gold Grenades – A fat little pot full of gold coins with a rainbow trail. When thrown, they explode in a shower of golden coins—deadly golden coins.

Fireball Wand – A magic wand with a red crystal on one end. The fireball explodes on impact.



Gravity Wand – Fling other characters into walls to increase your Slam Meter.

Ice Wand – A wand with a blue crystal on one end. Shoots an icy blue projectile that freezes the opponent in place.



Note: This is a time-based weapon and the player has it to use for only a few seconds.



Beehive – A cartoon beehive with little buzzing bees swirling around it. The bees don't mind being picked up and thrown, but if the beehive hits a character, it sticks on his or her head, and the bees attack!

Magnet – No one escapes the Magnet Wand! Draw them in, then pummel them silly.



Pirate Cannon – What's worse than someone shooting cannonballs at you? Ricocheting cannonballs!

Fairy Bazooka – Not all fairies are nice... This weapon shoots heat-seeking fairies that chase you down and attack you!



Hint: If your opponent is in Slam mode, use the **fairy bazooka** to attack them from a distance. With each hit, you'll be able to reduce their Slam and increase yours!

Note: Remember that you can equip and holster your weapons! Try setting up your opponents with weapons that paralyze them, then holster your weapon and attack.

Potions

You'll find vials filled with magical potions that temporarily enhance your character's abilities. Potions are automatically drunk when acquired.



Rocket Sauce – This powerful brew increases attack and movement speed.

Max Slam Juice – When drunk, this potion enables your slam attack.



Invisibility Potion – You disappear!

Invulnerability Potion – You cannot take damage.



Mystery Mix – This technicolor potion changes color constantly, and depending on what color it is when you grab it, you may get a good potion. Then again, maybe you won't.

Magical Items

Magical items appear throughout the levels. Just like potions, magical items are automatically triggered when grabbed and cannot be stored for later use. Keep a look out for them; you'll want to beat your opponents to these items. Grabbing the right magical item can easily mean the difference between winning and losing in *Shrek® SuperSlam*.



Viking Horned Helmet – A big, oversized Viking helmet with horns that turns every hit into a slam.

Hint: If you can manage to get a **fairy bazooka** AND a **viking horned helmet** at the same time, fire away! Each fairy will Slam your opponent.

Dragon Mask – The only thing worse than Shrek's breath is Dragon Fire. Slip on this dragon-shaped mask and make your presence known.



King's Crown – Trumpets will sound and the people will believe you are the King Returned! It's too bad all that cheering leaves people open to attack...





Magic Mirror Mask – A white mask that resembles the Magic Mirror. It reflects all missiles, but NOT melee weapons.

Pill Bug Ball – Transform into a ball and roll around hitting opponents with increased speed.



Dragon Sword – Harness the mighty power of the dragons with this gigantic fiery sword.

CHARACTERS

These are just some of the characters you'll find in *Shrek® SuperSlam*. As you advance through the game, you'll unlock more and more characters.



Shrek

Fighting style: Ogre Fist.

Slam Attack: Green Storm. A gas-based area attack that sends enemies flying. A real crowd pleaser.



Puss in Boots

A lover as well as a fighter, this dashing former assassin has seen the light, and now only fights for good (milk, that is).

Fighting style: Fencing.

Slam Attack: Hypno-Puss. You are powerless against his feline charms.

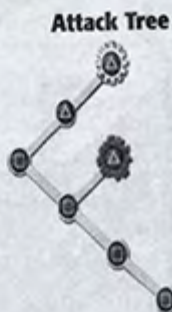

Princess Fiona (Human & Ogress)

Soft and delicate on the outside, but with a core of steel guaranteed to ring your bell!

Fighting style: Gentle Fist.

Slam Attack: Human—Bouquet of Blades.
Ogress—Ogre Aria.



Attack Tree Legend

- Big Score**
- Block Breaker**
- Special Move**



Donkey

Donkey's got a mouth that just won't quit as well as the heart of a noble steed.

Fighting style: Battering Ram.

Slam Attack: Donkey Stampede—Donkey's charge sends his enemies flying!



Gingerbread Man

His jolly cookie exterior serves to disguise the fierce Ninja Warrior lurking within...

Fighting style: Cane-Fu, Sugar Rush.

Slam Attack: Peppermint Fury. Gingy uses his various ninja skills to deliver an all-out shuriken attack.



Prince Charming

A Legend in his own mind.

Fighting style: Broadsword Combat.

Slam Attack: Charming's Roar—Charming's mighty sword smash blasts his opponents away.



Pinocchio

His bark is worse than his bite, but his fists are furious! He's gonna fight like a real boy!

Fighting style: Wooden Boxing, Marquess of Queensbury Rules.

Slam Attack: Buzz Bomber—Feel the Sting.

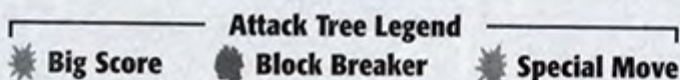

IN-GAME PAUSE MENU

To access options during gameplay, press the **START** button to bring up the Pause Menu with the following options:

Continue — Return to gameplay.

Restart — Restart current match.

Options — Bring up Options Menu.

Quit — Exit the current level and return to the menu.



SAVING & LOADING

You can save a game if you have a memory card (8MB)(for PlayStation®2) inserted into MEMORY CARD slot 1.

This game is equipped with an auto-save feature that keeps track of game data. Auto-save is triggered after every battle.

Auto-save also keeps track of Character Progression and Mega Challenges completed. Once enough mini-games are completed in those levels, auto-save will open up the next level automatically.

Loading

Autoload upon boot up with a memory card (8MB)(for PlayStation®2) with *Shrek® SuperSlam* saved data inserted into MEMORY CARD slot 1.

CREDITS

SHABA GAMES

Developed by Shaba Games

Animation

Matt D. Aldridge
Jeff Cooperman
Steve Ekstrom
Adam Green
Paul Hermann
David House
Ann Mikulka
Sean Nolan
Dean Ruggles
Peter Tsacle

Art

Paul Culp
Michelle Collins
Christopher Frenton
Will Hough
JR Jones
Patrick Kenney
Christopher Ledesma
Brandon Luyen
Alex Mathis
Damon Redmond
Genevieve Tsai
Scott Werner

Design

Seth Carus
Sylvain Dubrofsky
Zak Krefting
Quinlan Richards
Leif Simonson
Ryan Smith
Tom Teuscher
Joseph Wong
Noah Zilberberg

Production

Melanie Lam

Bill Mooney

Jason Nishino

Programming

Danny Burbol
Kevin Burnell
Shannon Greenwood
Michael Hough
Myriam Joire
Anthony Jules
Alan Latham
Jeff Lowe
Robert Morgan
Tim O'Neil
Corey Revilla
Naveen Vemuri
Hal Wasserman

Sound

Lorien Ferris

Testers

Tomasi Akimeta
Peter Chow
Tim Erbil
Thomas Grové
Shaheed Khan
Joel Rainey

Shabans

Jennie Davis
Rick D'Aloisio
Bradley Fulton
Kimberly Haq
Zelman Helmer
Paul Kwinn
Tim Lander
Nik Marquez
Jon Menzies
Tamsen Mitchell
Elise Mundell
Vince Riley

Adam Ruja
Chris Scholz
Mark Walters

TOYS FOR BOB

Additional design by
Toys for Bob

Artists

Laurie Franks
Josh Lindeman
Robin Lujan
Don Martinez
Sunil Mukherjee
Guy Riessen

Animators

Mike Dacko
I-Wei Huang
Dave Huddleston
Dan Ross
Rick Servande

Designers

John Barnes
Nat Loh
Chris Nelson
Erol Otus
Adi Taylor
Ray West

SPECIAL THANKS TO:

Animation

Noah Bordner
Romy Cayetano
Jeff Kim
Rick May
Paul Mikulecky
Jason Patnode

Art

Dave Yee
Mike O'Rourke



Sound
Burke Trieschmann

Writing
Brian Kahn
David Pitlik

Programming
Wade Brainerd
Krassimir Touevsky
John Allensworth
Yu Ping Hu
Christian Diefenbach

Additional Thanks
To the kids who
focus-tested our game
Caroline Horn

DREAMWORKS ANIMATION

Special Thanks to
Paul Elliott
Anne Globe
Raman Hui
Amy Krider
John Moore
Meaghan Nix
Rick Rekedal
Aron Warner
Chris Miller
Denise Cascino
... and the entire PDI team

ACTIVISION

PRODUCTION

Producer
TQ Jefferson

Executive Producer
Chris Hewish

Associate Producers
Jay Gordon
Aaron Gray
Lalie Fisher

Production Coordinators
Vanessa Schlais
Jeremy Evangelista

VP, North American Studios
Laird Malamed

Localization Manager
Matt Morton

MARKETING AND PR
Global Brand Manager
Kirsten Duvall

**Vice President,
Global Brand Management**
David Pokress

**Director,
Global Brand Management**
Rachel Silverstein

Associate Brand Manager
Dan Lazar

**Manager, Corporate
Communications**
Lisa Fields

Publicists
Kate Mitchum
Lindsay Morio

Packaging Design
Hamagami/Carroll, Inc.

Manual Design
Ignited Minds

Special Thanks
Ron Doornink, Mike Griffith,
Kathy Vrabeck, Chuck Huebner,
Robin Kaminsky, Paul Reiche III

ACTIVISION UK
Localization Project Manager
Charlotte Harris

*QUALITY ASSURANCE/
CUSTOMER SUPPORT*

Project Leads
Alex Ortiz
Danny Oleson

Senior Project Lead
Jason "Fox" Potter

Senior QA Manager
Tim Vanlaw

Floor Leads
Jon Weinewski
Shawna Wylie
Michael Smith
Charles Moore

Testers
Chip Myers
Jonathon Hall
Jay Evans
John Holdeman
Darren Manci
Chris Daroza
Alexei Bepalov
Todd Gardiner
Brett Johnson
Benny Phanichkul
Derek Reid
Jack Anderson
Kellen Anderson
Phil Sandhop
Bobby Munguia
James Cha
Zaccheus Roserie

Zac Blitz
Matt Dunn
Pokee Chan
David Lee
Romel Cabuena
Kurt Mathes

Christabelle-Ann Soriano
David Siner

Jeremy Silvis
Gavin Kennedy
Alfredo Gallard
Jacob Cristobal
Christopher Sampson
Ryan Blosser
Charles Putman
Jeremy Weaver
Jerry Pritchard
Ward Beishline

Special Thanks
The *Shrek*® film team at
DreamWorks and PDI

MUSIC
Kevin Manthei
Kevin Riepl
Kevin Manthei Music
kmmproductions.com

Track Remixes by
DJ Peyote Cody

Additional Music
Mike Patti
Brian Barrale
Aaron Molho

SOUND
Casting & Voice Direction
Kris Zimmerman

**Recording/Engineering/
Editing/Voiceover**
Salami Studios
Marc Mercado, M.P.S.E.
Devon Bowman, M.P.S.E.

VOICEOVERS
Shrek/Wolf
Michael Gough

Quasimodo
Nolan North

Fiona/Fiona Ogress
Holly Fields

Donkey
Mark Mosley

Gingy
Conrad Vernon

Puss/Robin Hood
Andre Sogluccio

Pinocchio
Cody Cameron

Announcer/Hook
John Kassir

Prince/Humpty
James Arnold Taylor

Red/Unicorn/Dronkey/Lil Witch
Tara Strong

Cyclops/Black Knight/G-nome
Max Koch



CUSTOMER SUPPORT

Note: Please do not contact Customer Support for hints/codes/cheats; only technical issues.

Internet: <http://www.activision.com/support>

Our support section of the web has the most up-to-date information available. We update the support pages daily, so please check here first for solutions. If you cannot find an answer to your issue, you can submit a question/incident to us using the online support form. A response may take anywhere from 24-72 hours depending on the volume of messages we receive and the nature of your problem.

Note: Internet support is handled in English only.

Note: The multiplayer components of Activision games are handled only through Internet support.

Phone: (310) 255-2050

You can call our 24-hour voice-mail system for answers to our most frequently asked questions at the above number. Contact a Customer Support representative at the same number between the hours of 9:00 am and 5:00 pm (Pacific Time), Monday through Friday, except holidays.

Please do not send any game returns directly to Activision without first contacting Customer Support. It is our policy that game returns/refunds must be dealt with by the retailer or online site where you purchased the product. Please see the Limited Warranty contained within our Software License Agreement for warranty replacements.

**Register your product online at www.activision.com
so we can enter you in our monthly drawing
for a fabulous Activision prize.**



Software License Agreement

USE OF THIS PROGRAM IS SUBJECT TO THE SOFTWARE LICENSE TERMS SET FORTH BELOW. "PROGRAM" INCLUDES THE SOFTWARE INCLUDED WITH THIS AGREEMENT, THE ASSOCIATED MEDIA, ANY PRINTED MATERIALS, AND ANY ON-LINE OR ELECTRONIC DOCUMENTATION, AND ANY AND ALL COPIES AND DERIVATIVE WORKS OF SUCH SOFTWARE AND MATERIALS. BY OPENING THIS PACKAGE, AND/OR USING THE PROGRAM, YOU ACCEPT THE TERMS OF THIS LICENSE WITH ACTIVISION, INC. ("ACTIVISION").

LIMITED USE LICENSE. Activision grants you the non-exclusive, non-transferable, limited right and license to use one copy of this Program solely and exclusively for your personal use. All rights not specifically granted under this Agreement are reserved by Activision. This Program is licensed, not sold. Your license confers no title or ownership in this Program and should not be construed as a sale of any rights in this Program.

OWNERSHIP. All title, ownership rights and intellectual property rights in and to this Program and any and all copies thereof (including but not limited to any titles, computer code, themes, objects, characters, character names, stories, dialog, catch phrases, locations, concepts, artwork, animation, sounds, musical compositions, audio-visual effects, methods of operation, moral rights, and any related documentation, incorporated into this Program) are owned by Activision or its licensors. This Program is protected by the copyright laws of the United States, international copyright treaties and conventions and other laws. This Program contains certain licensed materials and Activision's licensors may protect their rights in the event of any violation of this Agreement.

YOU SHALL NOT:

- Exploit this Program or any of its parts commercially, including but not limited to use at a cyber cafe, computer gaming center or any other location-based site. Activision may offer a separate Site License Agreement to permit you to make this Program available for commercial use; see the contact information below.
- Sell, rent, lease, license, distribute or otherwise transfer this Program, or any copies of this Program, without the express prior written consent of Activision.
- Reverse engineer, derive source code, modify, decompile, disassemble, or create derivative works of this Program, in whole or in part.
- Remove, disable or circumvent any proprietary notices or labels contained on or within the Program.
- Export or re-export this Program or any copy or adaptation in violation of any applicable laws or regulations.

LIMITED WARRANTY. Activision warrants to the original consumer purchaser of this Program that the recording medium on which the Program is recorded will be free from defects in material and workmanship for 90 days from the date of purchase. If the recording medium is found defective within 90 days of original purchase, Activision agrees to replace, free of charge, any product discovered to be defective within such period upon its receipt of the Product, postage paid, with proof of the date of purchase, as long as the Program is still being manufactured by Activision. In the event that the Program is no longer available, Activision retains the right to substitute a similar program of equal or greater value. This warranty is limited to the recording medium containing the Program as originally provided by Activision and is not applicable to normal wear and tear. This warranty shall not be applicable and shall be void if the defect has arisen through abuse, mistreatment, or neglect. Any implied warranties prescribed by statute are expressly limited to the 90-day period described above.

EXCEPT AS SET FORTH ABOVE, THIS WARRANTY IS IN LIEU OF ALL OTHER WARRANTIES, WHETHER ORAL OR WRITTEN, EXPRESS OR IMPLIED, INCLUDING ANY WARRANTY OF MERCHANTABILITY, FITNESS FOR A PARTICULAR PURPOSE OR NON-INFRINGEMENT, AND NO OTHER REPRESENTATIONS OR CLAIMS OF ANY KIND SHALL BE BINDING ON OR OBLIGATE ACTIVISION.

When returning the Program for warranty replacement please send the original product disks only in protective packaging and include: (1) a photocopy of your dated sales receipt; (2) your name and return address typed or clearly printed; (3) a brief note describing the defect, the problem(s) you are encountered and the system on which you are running the Program; (4) if you are returning the Program after the 90-day warranty period, but within one year after the date of purchase, please include check or money order for \$20 U.S. currency per disc replacement. Note: Certified mail recommended.

In the U.S. send to: Warranty Replacements, Activision, Inc., P.O. Box 67713, Los Angeles, California 90067

LIMITATION ON DAMAGES. IN NO EVENT WILL ACTIVISION BE LIABLE FOR SPECIAL, INCIDENTAL OR CONSEQUENTIAL DAMAGES RESULTING FROM POSSESSION, USE OR MALFUNCTION OF THE PROGRAM, INCLUDING DAMAGES TO PROPERTY, LOSS OF GOODWILL, COMPUTER FAILURE OR MALFUNCTION AND, TO THE EXTENT PERMITTED BY LAW, DAMAGES FOR PERSONAL INJURIES, EVEN IF ACTIVISION HAS BEEN ADVISED OF THE POSSIBILITY OF SUCH DAMAGES. ACTIVISION'S LIABILITY SHALL NOT EXCEED THE ACTUAL PRICE PAID FOR THE LICENSE TO USE THIS PROGRAM. SOME STATES/COUNTRIES DO NOT ALLOW LIMITATIONS ON HOW LONG AN IMPLIED WARRANTY LASTS AND/OR THE EXCLUSION OR LIMITATION OF INCIDENTAL OR CONSEQUENTIAL DAMAGES, SO THE ABOVE LIMITATIONS AND/OR EXCLUSION OR LIMITATION OF LIABILITY MAY NOT APPLY TO YOU. THIS WARRANTY GIVES YOU SPECIFIC LEGAL RIGHTS, AND YOU MAY HAVE OTHER RIGHTS WHICH VARY FROM JURISDICTION TO JURISDICTION.

TERMINATION. Without prejudice to any other rights of Activision, this Agreement will terminate automatically if you fail to comply with its terms and conditions. In such event, you must destroy all copies of this Program and all of its component parts.

U.S. GOVERNMENT RESTRICTED RIGHTS. The Program and documentation have been developed entirely at private expense and are provided as "Commercial Computer Software" or "restricted computer software." Use, duplication or disclosure by the U.S. Government or a U.S. Government subcontractor is subject to the restrictions set forth in subparagraph (c)(1)(ii) of the Rights in Technical Data and Computer Software clauses in DFARS 252.227-7013 or as set forth in subparagraph (c)(1) and (2) of the Commercial Computer Software Restricted Rights clauses at FAR 52.227-19, as applicable. The Contractor/Manufacturer is Activision, Inc., 3100 Ocean Park Boulevard, Santa Monica, California 90405.

INJUNCTION. Because Activision would be irreparably damaged if the terms of this Agreement were not specifically enforced, you agree that Activision shall be entitled, without bond, other security or proof of damages, to appropriate equitable remedies with respect to breaches of this Agreement, in addition to such other remedies as Activision may otherwise have under applicable laws.

INDEMNITY. You agree to indemnify, defend and hold Activision, its partners, affiliates, contractors, officers, directors, employees and agents harmless from all damages, losses and expenses arising directly or indirectly from your acts and omissions to act in using the Product pursuant to the terms of this Agreement.

MISCELLANEOUS. This Agreement represents the complete agreement concerning this license between the parties and supersedes all prior agreements and representations between them. It may be amended only by a writing executed by both parties. If any provision of this Agreement is held to be unenforceable for any reason, such provision shall be reformed only to the extent necessary to make it enforceable and the remaining provisions of this Agreement shall not be affected. This Agreement shall be construed under California law as such law is applied to agreements between California residents entered into and to be performed within California, except as governed by federal law and you consent to the exclusive jurisdiction of the state and federal courts in Los Angeles, California. If you have any questions concerning this license, you may contact Activision at 3100 Ocean Park Boulevard, Santa Monica, California 90405, (310) 255-2000, Attn. Business and Legal Affairs, legal@activision.com.

SOFTWARE LICENSE AGREEMENT

USE OF THIS PROGRAM IS SUBJECT TO THE SOFTWARE LICENSE TERMS SET FORTH BELOW. "PROGRAM" INCLUDES THE SOFTWARE INCLUDED WITH THIS AGREEMENT, THE ASSOCIATED MEDIA, ANY PRINTED MATERIALS, AND ANY ON-LINE OR ELECTRONIC DOCUMENTATION, AND ANY AND ALL COPIES AND DERIVATIVE WORKS OF SUCH SOFTWARE AND MATERIALS. BY OPENING THIS PACKAGE, AND/OR USING THE PROGRAM, YOU ACCEPT THE TERMS OF THIS LICENSE WITH ACTIVISION, INC. ("ACTIVISION")

LIMITED USE LICENSE. Activision grants you the non-exclusive, non-transferable, limited right and license to use one copy of this Program solely and exclusively for your personal use. All rights not specifically granted under this Agreement are reserved by Activision. This Program is licensed, not sold. Your license confers no title or ownership in this Program and should not be construed as a sale of any rights in this Program.

OWNERSHIP. All title, ownership rights and intellectual property rights in and to this Program and any and all copies thereof (including but not limited to any titles, computer code, themes, objects, characters, character names, stories, dialog, catch phrases, locations, concepts, artwork, animation, sounds, musical compositions, audio-visual effects, methods of operation, moral rights, and any related documentation, incorporated into this Program) are owned by Activision or its licensors. This Program is protected by the copyright laws of the United States, international copyright treaties and conventions and other laws. This Program contains certain licensed materials and Activision's licensors may protect their rights in the event of any violation of this Agreement.

YOU SHALL NOT:

- Exploit this Program or any of its parts commercially, including but not limited to use at a cyber cafe, computer gaming center or any other location-based site. Activision may offer a separate Site License Agreement to permit you to make this Program available for commercial use; see the contact information below.
- Sell, rent, lease, license, distribute or otherwise transfer this Program, or any copies of this Program, without the express prior written consent of Activision.
- Reverse engineer, derive source code, modify, decompile, disassemble, or create derivative works of this Program, in whole or in part.
- Remove, disable or circumvent any proprietary notices or labels contained on or within the Program.
- Export or re-export this Program or any copy or adaptation in violation of any applicable laws or regulations.

LIMITED WARRANTY. Activision warrants to the original consumer purchaser of this Program that the recording medium on which the Program is recorded will be free from defects in material and workmanship for 90 days from the date of purchase. If the recording medium is found defective within 90 days of original purchase, Activision agrees to replace, free of charge, any product discovered to be defective within such period upon its receipt of the Product, postage paid, with proof of the date of purchase, as long as the Program is still being manufactured by Activision. In the event that the Program is no longer available, Activision retains the right to substitute a similar program of equal or greater value. This warranty is limited to the recording medium containing the Program as originally provided by Activision and is not applicable to normal wear and tear. This warranty shall not be applicable and shall be void if the defect has arisen through abuse, mistreatment, or neglect. Any implied warranties prescribed by statute are expressly limited to the 90-day period described above.

EXCEPT AS SET FORTH ABOVE, THIS WARRANTY IS IN LIEU OF ALL OTHER WARRANTIES, WHETHER ORAL OR WRITTEN, EXPRESS OR IMPLIED, INCLUDING ANY WARRANTY OF MERCHANTABILITY, FITNESS FOR A PARTICULAR PURPOSE OR NON-INFRINGEMENT, AND NO OTHER REPRESENTATIONS OR CLAIMS OF ANY KIND SHALL BE BINDING ON OR OBLIGATE ACTIVISION.

When returning the Program for warranty replacement please send the original product disks only in protective packaging and include: (1) a photocopy of your dated sales receipt; (2) your name and return address typed or clearly printed; (3) a brief note describing the defect, the problem(s) you are encountering and the system on which you are running the Program; (4) if you are returning the Program after the 90-day warranty period, but within one year after the date of purchase, please include check or money order for \$20 U.S. currency per disc replacement. Note:

Certified mail recommended.

In the U.S. send to: Warranty Replacements, Activision, Inc., P.O. Box 67713, Los Angeles, California 90067

LIMITATION ON DAMAGES. IN NO EVENT WILL ACTIVISION BE LIABLE FOR SPECIAL, INCIDENTAL OR CONSEQUENTIAL DAMAGES RESULTING FROM POSSESSION, USE OR MALFUNCTION OF THE PROGRAM, INCLUDING DAMAGES TO PROPERTY, LOSS OF GOODWILL, COMPUTER FAILURE OR MALFUNCTION, AND, TO THE EXTENT PERMITTED BY LAW, DAMAGES FOR PERSONAL INJURIES, EVEN IF ACTIVISION HAS BEEN ADVISED OF THE POSSIBILITY OF SUCH DAMAGES. ACTIVISION'S LIABILITY SHALL NOT EXCEED THE ACTUAL PRICE PAID FOR THE LICENSE TO USE THIS PROGRAM. SOME STATES/COUNTRIES DO NOT ALLOW LIMITATIONS ON HOW LONG AN IMPLIED WARRANTY LASTS AND/OR THE EXCLUSION OR LIMITATION OF INCIDENTAL OR CONSEQUENTIAL DAMAGES, SO THE ABOVE LIMITATIONS AND/OR EXCLUSION OR LIMITATION OF LIABILITY MAY NOT APPLY TO YOU. THIS WARRANTY GIVES YOU SPECIFIC LEGAL RIGHTS, AND YOU MAY HAVE OTHER RIGHTS WHICH VARY FROM JURISDICTION TO JURISDICTION.

TERMINATION. Without prejudice to any other rights of Activision, this Agreement will terminate automatically if you fail to comply with its terms and conditions. In such event, you must destroy all copies of this Program and all of its component parts.

U.S. GOVERNMENT RESTRICTED RIGHTS. The Program and documentation have been developed entirely at private expense and are provided as "Commercial Computer Software" or "restricted computer software." Use, duplication or disclosure by the U.S. Government or a U.S. Government subcontractor is subject to the restrictions set forth in subparagraph (c)(1)(ii) of the Rights in Technical Data and Computer Software clauses in DFARS 252.227-7013 or as set forth in subparagraph (c)(1) and (2) of the Commercial Computer Software Restricted Rights clauses at FAR 52.227-19, as applicable. The Contractor/Manufacturer is Activision, Inc., 3100 Ocean Park Boulevard, Santa Monica, California 90405.

INJUNCTION. Because Activision would be irreparably damaged if the terms of this Agreement were not specifically enforced, you agree that Activision shall be entitled, without bond, other security or proof of damages, to appropriate equitable remedies with respect to breaches of this Agreement, in addition to such other remedies as Activision may otherwise have under applicable laws.

INDEMNITY. You agree to indemnify, defend and hold Activision, its partners, affiliates, contractors, officers, directors, employees and agents harmless from all damages, losses and expenses arising directly or indirectly from your acts and omissions to act in using the Product pursuant to the terms of this Agreement.

MISCELLANEOUS. This Agreement represents the complete agreement concerning this license between the parties and supersedes all prior agreements and representations between them. It may be amended only by a writing executed by both parties. If any provision of this Agreement is held to be unenforceable for any reason, such provision shall be reformed only to the extent necessary to make it enforceable and the remaining provisions of this Agreement shall not be affected. This Agreement shall be construed under California law as such law is applied to agreements between California residents entered into and to be performed within California, except as governed by federal law and you consent to the exclusive jurisdiction of the state and federal courts in Los Angeles, California. If you have any questions concerning this license, you may contact Activision at 3100 Ocean Park Boulevard, Santa Monica, California 90405, (310) 255-2000, Attn: Business and Legal Affairs, legal@activision.com.

DREAMWORKS

MADAGASCAR™

Available
NOW!

www.MADAGASCAR-theGAME.com



DREAMWORKS

OVER THE HEDGE™ THE GAME

COMING MAY 2006

SEE TRAILER INSIDE GAME.

ACTIVISION

activision.com

DREAMWORKS
ANIMATION SKG



PlayStation 2

PRODUCTS RANGE FROM
RATING PENDING TO EVERYONE 10+

RP-E
10+
CONTENT RATED BY
ESRB

Madagascar TM & © 2005 DreamWorks Animation L.L.C. Developed by Toys for Bob. Over the Hedge TM & © 2005 DreamWorks Animation L.L.C. Developed by Edge of Reality. Shrek © and © Dreamworks Animation L.L.C. All Rights Reserved. Developed by Shaba Games. Game © 2005 Activision Publishing, Inc. Activision is a registered trademark of Activision Publishing, Inc. All rights reserved. "PlayStation" and the "PS" Family logo are registered trademarks of Sony Computer Entertainment Inc. The ratings icon is a registered trademark of the Entertainment Software Association. All other trademarks and trade names are the properties of their respective owners. 80977.226.US